

Article number: 204490ZD801SW
 Description: E+G Ball catches
 GN 4490-ZD-80-1-SW

Measures

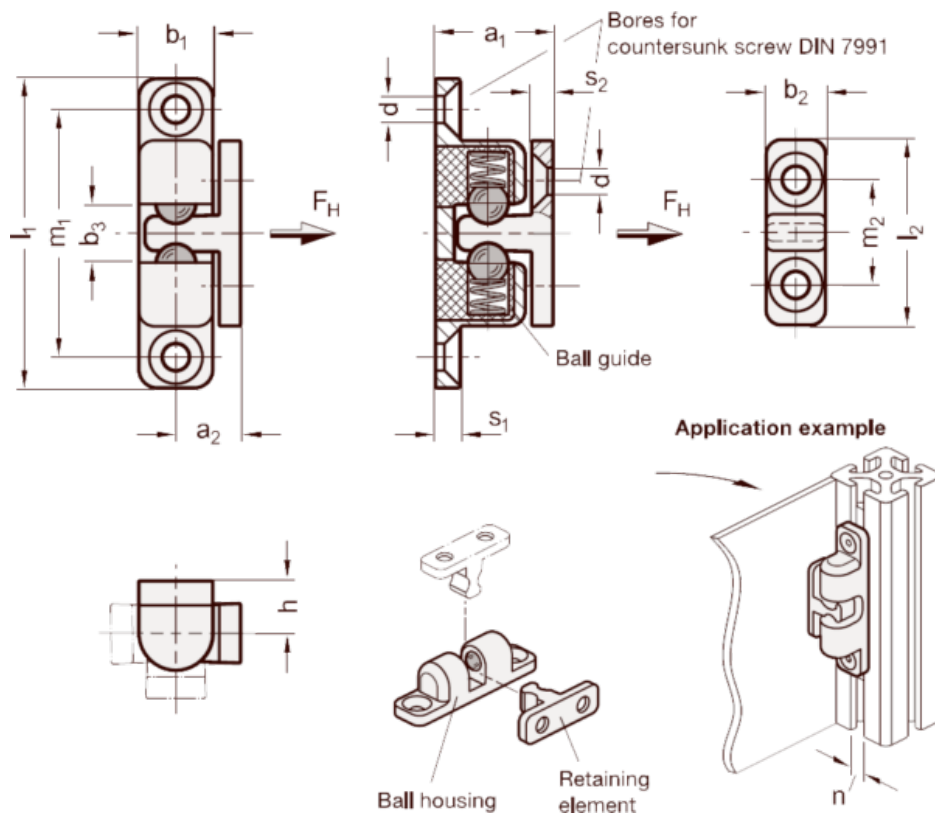

a1	= 27	Holding force FH in N = 95
a2	= 14	l1 = 80
b1	= 16.5	l2 = 40
b2	= 13	m1 = 65
b3	= 11	m2 = 25
d	= M 5	s1 = 6
for nut width n = ?	10	s2 = 4
h	= 13	Weight in (g) = 88